

678 560

Radius-Vor-/Rückwärtsentgrater VHM+X.Cut Lang
Carbide Radius Forward / Backward Deburrer+X.Cut Long Version

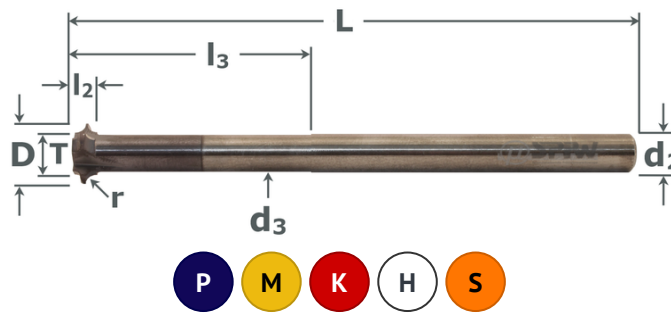

- Doppelt geschliffen, 1/4-Kreisprofil
- Überlange Ausführung
- Vor/Rück-Entgraten von Radien
- Lange Version für Zugangsprobleme
- Oberfläche X.Cut beschichtet
- 1/4 circle ground on both sides
- Extra long version
- Forward/backward radial deburring
- Difficult access areas
- With X.Cut coating



VHM	X Cut
z: 2-3	DIN 6535HA
L lang	Radius

r Radius	ØD max.	Ød2 h5	Ød3 x l3	L	l1	l2	z	x	y	Art. No.	Stk/pce Euro
0,2	1,9	3	1,25 x 8	60	0,9	1,45	2	0,87	1,32	6785600203	54,60
0,3	2,3	3	1,45 x 9	60	1,2	1,95	2	1,07	1,82	6785600303	54,60
0,4	2,6	3	1,55 x 10	60	1,55	2,5	2	1,22	2,37	6785600403	54,60
0,5	2,9	3	1,65 x 12	60	1,85	3	2	1,37	2,87	6785600503	54,60
0,5	4,9	6	3,65 x 20	100	2,15	3,3	3	2,37	3,17	6785600506	81,50
0,6	5,2	6	3,75 x 25	100	2,14	3,5	3	2,52	3,37	6785600606	81,50
0,8	5,9	6	4,05 x 30	100	2,14	3,9	3	2,89	3,77	6785600806	81,50
1	6,6	8	4,35 x 35	100	2,23	4,3	3	3,22	4,19	6785601008	89,60
1,2	7,4	8	4,75 x 35	100	2,63	5,2	3	3,62	5,07	6785601208	89,60
1,5	8,4	10	5,1 x 35	100	2,73	5,8	3	4,12	5,77	6785601508	89,60
1,8	9,3	10	5,4 x 35	100	2,72	6,4	3	4,57	6,37	6785601809	124,70
2	9,9	10	5,6 x 35	100	2,82	6,8	3	4,87	6,87	6785602009	124,70
2,5	10,9	12	5,6 x 35	100	2,9	7,8	3	5,37	7,97	6785602510	150,70
3	11,9	12	5,6 x 35	100	3	8,8	3	5,87	9,07	6785603011	150,70





— INFO —

— INFO —

Radius-Vorwärts-Rückwärts-Entgrater
 Radius Forward and Backward Deburrer

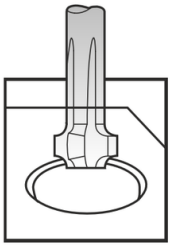

Vorwärts | Forward

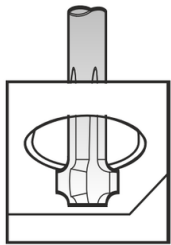
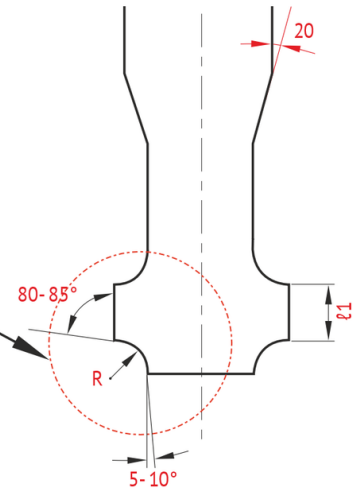
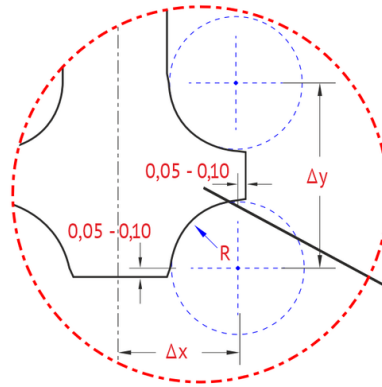
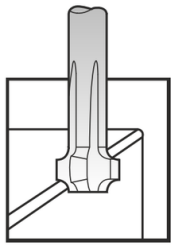

Rückwärts | Backward

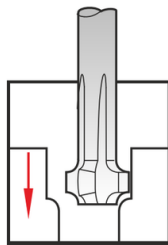
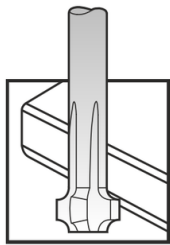

Profilieren | Profiling

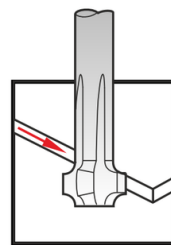

G